

Desk monitor arm

We are committed to making product choices that are sustainable and rely on the recyclability of our products. Investing in a circular economy where sustainability is at the heart of everything we do. A sustainable approach is essential in addressing global climate change.

Environmental footprint

Greenhouse gasses emitted into the environment during production of a product contribute directly to our planet's global warming.

Using LCA software¹ we are able to calculate² the (potential) environmental footprint, measured in kilograms CO₂-equivalent. This enables us to evaluate a product's footprint and support the design of sustainable products.

By recycling our products the impact on the environment can be reduced as the recycled material replace the need to produce virgin materials.

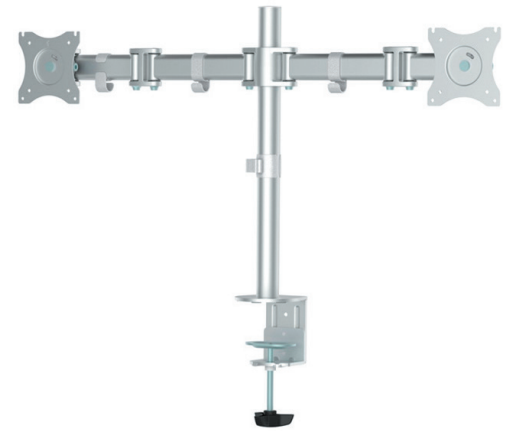

Neomounts



Steel	92,4%
Aluminium	5,2%
ABS	1,2%
PA	0,7%
POM	0,4%
Other	0,1%

Emitted carbon dioxide

To illustrate the effect of a kilogram carbon dioxide, we converted it to kilometres driven by a car.



Without recycling

22,45 kg CO₂
68 km*

With recycling

14,21 kg CO₂
43 km*

NM-D135DSILVER

	Steel	Aluminium	ABS	PA	POM	Other	Total
Material weight (g)	4639,8	261,9	62,6	35,7	18,7	3,0	5021,6
Kilograms CO₂-equivalent							
Without recycling	17,58	4,02	0,39	0,33	0,08	0,06	22,45
Recycling reduction %							37%
With recycling	11,03	2,37	0,36	0,31	0,07	0,06	14,21

*8 litres of petrol per 100 km ²

Sources: ¹ Mobius Ecochain - Ecoinvent v3.6, ² According to EN15804+A2, ³ Foundation myclimate; based on 8 litres of petrol per 100 km

